



## ROUGH TERRAIN CRANE RT 670

DATASHEET - IMPERIAL



# RT 670

### Features:

- ▶ Rated capacity:  
70 ton @ 9 ft working radius
- ▶ Maximum boom length:  
111 ft
- ▶ Maximum tip height:  
170 ft

**WORKS FOR YOU.™**

## Key

.....	3
-------	---

## Dimensions

Crane dimensions .....	4
Crane weights .....	5

## Load charts

Range Diagram – Main Boom – Outriggers fully extended (100%) .....	6
Load Chart – Main Boom – Outriggers fully extended (100%) .....	7
Range Diagram – Main Boom – Outriggers fully retracted (0%) .....	8
Load Chart – Main Boom – Outriggers fully retracted (0%) .....	9
Range Diagram – Main Boom – 33 ft offsettable jib .....	10
Load Chart – Main Boom – 33 ft offsettable jib .....	11
Range Diagram – Main Boom – 57 ft offsettable jib .....	12
Load Chart – Main Boom – 57 ft offsettable jib .....	13
Range Diagram – Main Boom – On tires .....	14
Load Chart – Main Boom – On tires .....	15

## Technical description

Boom .....	16
Hoist, rope and hook .....	16, 17
Superstructure .....	17
Cab, controls, operator aids and load limiter / load indicator .....	17, 18
Carrier, engine, drive-line and hydraulic system .....	18
Vehicle performance .....	19
Tires .....	19

	Counterweight		General performance
	Main boom		Telescoping mode
	Boom length		Boom luffing angle
	Tip height		Working radius
	Boom with extension		Max. boom length with extension
	Main boom with aux head		Distance from the hook to the head sheave pin
	Slewing / Allowable slewing range		Slewing locked / Slewing locked at specified position
	Slewing brake		Slewing gears
	Outriggers / Lifting on outriggers (100/50/0% extended)		Lifting on wheels / Pick & Carry
	Main hoist		Auxiliary hoist
	Hoist speed		Rope length
	Rope - Standard / Optional		Max. line pull
	Rope diameter		Tire
	Hook block		Controls
	Cab		Engine
	Operator aids / Load limiter / Load indicator		Steering
	Mechanical transmission		Speed
	HYDR Hydraulics		Heating / Air conditioning
	Working temperature		Gradeability
	Lights		Gross vehicle weight
	Crane / Crane in standard configuration		Weight on front axle
	Crane without counterweight		Weight on rear axle

# CRANE DIMENSIONS

**RT 670**

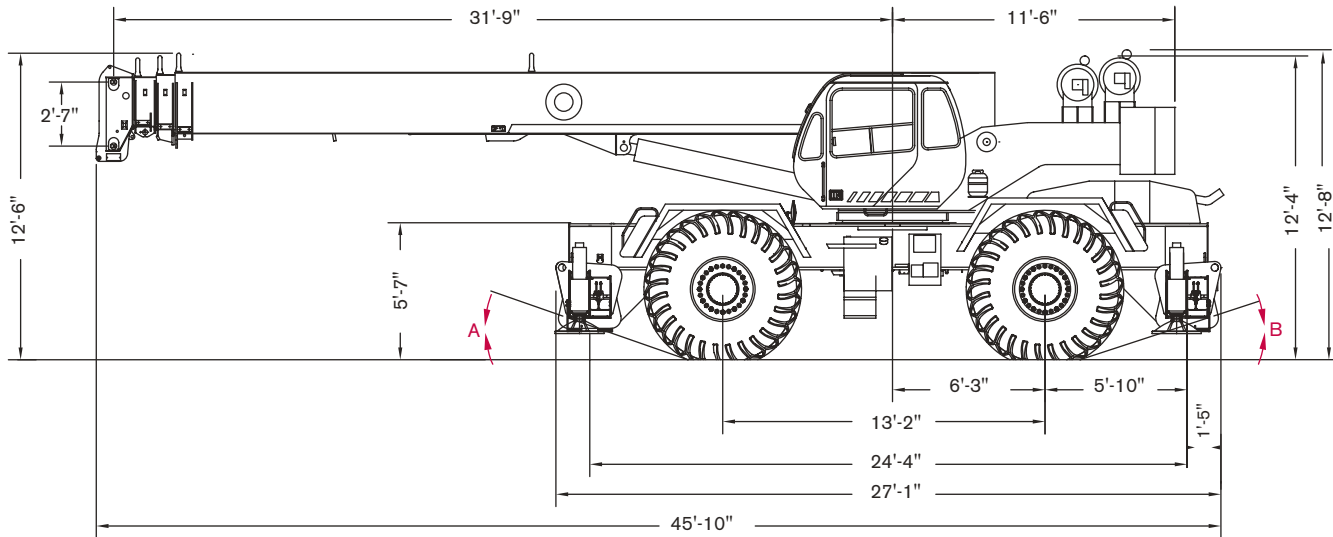

**Note:** All heights based on 26.5 X 25-26 PR tires.

Angles	
A (Approach Angle)	19°
B (Departure Angle)	18°

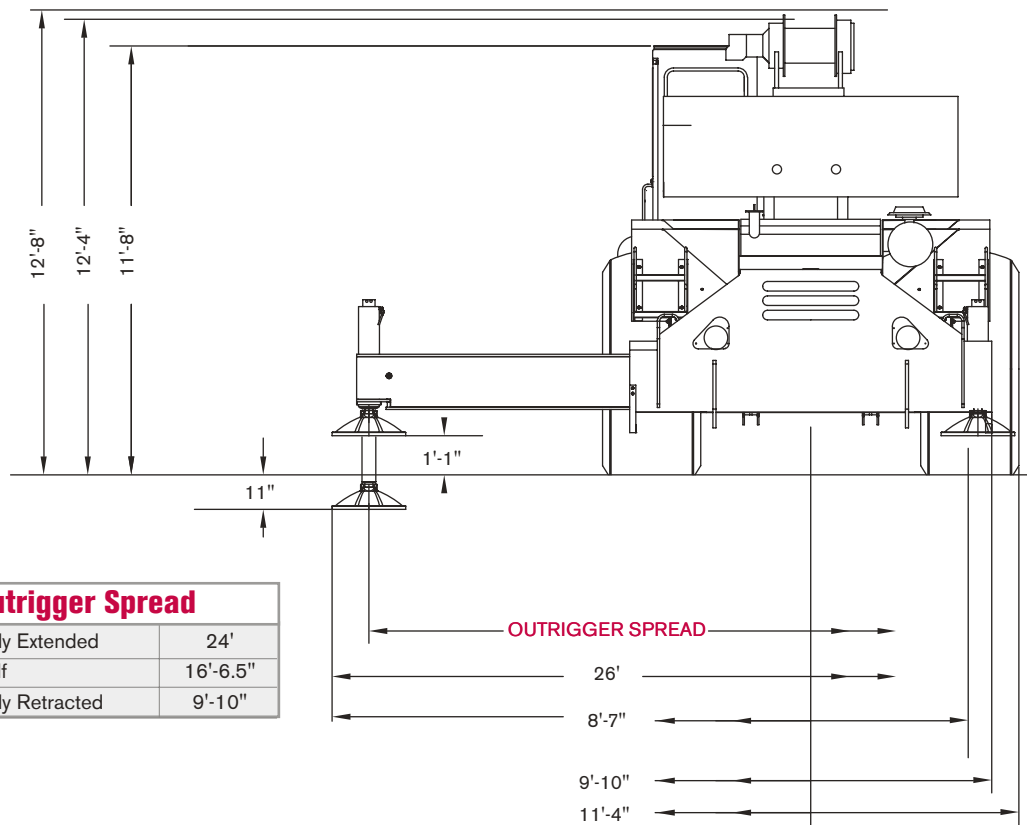

Outrigger Spread	
Fully Extended	24'
Half	16'-6.5"
Fully Retracted	9'-10"

# CRANE WEIGHTS

**RT 670**

## Approximate Weights

	STD (without hook block)	85,694 lb	45,238 lb	40,456 lb
Add / Subtract for main optional equipment				
	33 ft to 57 ft swing on jib stowed	+ 2,170 lb	+ 3,580 lb	- 1,410 lb
	Auxiliary boom head	+ 125 lb	+ 365 lb	- 240 lb
	Auxiliary hoist*	+ 584 lb	- 30 lb	+ 614 lb
	5 sheaves, 75T	+ 1,040 lb	+ 1,971 lb	- 931 lb
	5 sheaves, 60T	+ 1,204 lb	+ 2,233 lb	- 1,029 lb

NOTE: Values are subject to 2% variation

\* Weight includes rope

# RANGE DIAGRAM - MAIN BOOM

**RT 670**

**Outriggers Fully Extended (100%)**

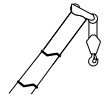

 with hook block:  
6 ft 9 in

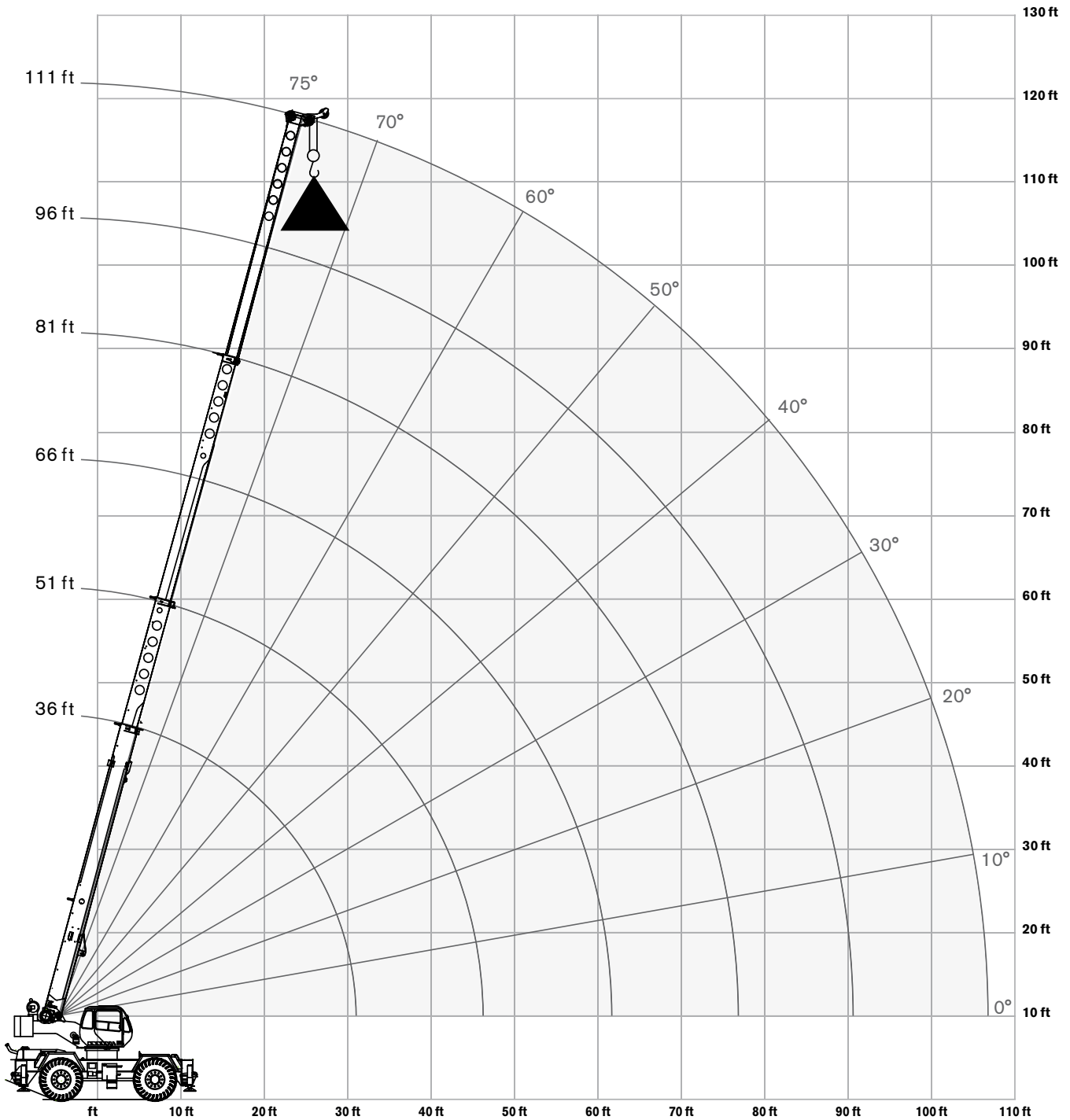



# LOAD CHART- MAIN BOOM

**RT 670**

## Outriggers Fully Extended (100%)

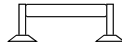
 14,200 lbs counterweight

 Outriggers extended 24 ft (100%)

 360 degree rotation

Standard ASME B30.5

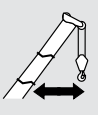
	Boom Length						
	35 ft	51 ft	66 ft	81 ft	96 ft	111 ft	
ft	lb	lb	lb	lb	lb	lb	ft
9	140,000						9
10	130,000	80,000					10
12	106,700	80,000					12
15	85,800	78,400	61,900				15
20	62,000	63,300	54,800	46,200			20
25	47,600	48,800	49,100	40,700	35,300		25
30	37,700	39,100	39,800	36,000	31,200	27,500	30
35		32,200	32,900	32,300	28,000	24,800	35
40		26,900	27,400	27,800	25,300	22,500	40
45		21,300	22,100	22,400	22,600	20,600	45
50			18,200	18,500	18,700	18,800	50
55			15,100	15,500	15,700	15,800	55
60			12,600	13,100	13,300	13,400	60
65				11,200	11,400	11,500	65
70				9,500	9,800	9,900	70
75				8,100	8,400	8,600	75
80					7,300	7,400	80
85					6,200	6,400	85
90					5,300	5,600	90
95						4,800	95
100						4,100	100
105						3,500	105

### Notes to lifting capacity

Lifting capacities do not exceed 85% of tipping load. Weight of hook blocks and slings is part of the load, and is to be deducted from the capacity ratings. Consult operation manual for further details.

Note: Data published herein is intended as a guide only and shall not be construed to warrant applicability for lifting purposes. Crane operation is subject to the computer charts and operation manual both supplied with the crane.

# RANGE DIAGRAM - MAIN BOOM

**RT 670**

**Outriggers Fully Retracted (0%)**

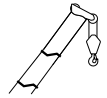

with hook block:  
6 ft 9 in

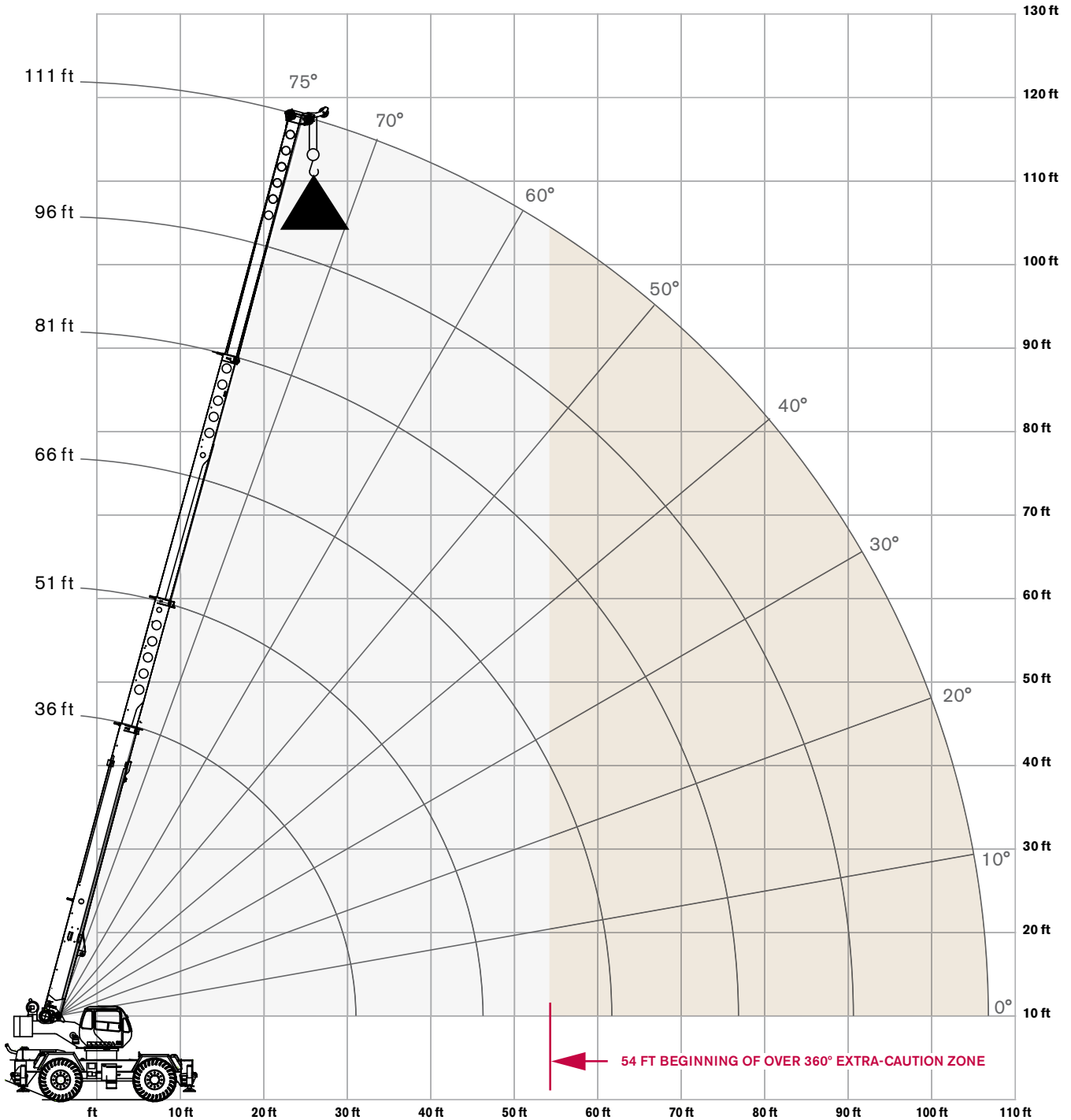



# LOAD CHART- MAIN BOOM

**RT 670**

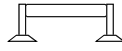

## Outriggers Fully Retracted (0%)

 14,200 lbs counterweight

 Outriggers retracted 9 ft 10 in (0%)

 360 degree rotation

Standard ASME B30.5

	Boom Length						
	35 ft	51 ft	66 ft	81 ft	96 ft	111 ft	
ft	lb	lb	lb	lb	lb	lb	ft
10	73,600	74,800					10
12	51,600	52,600					12
15	34,200	35,200	35,700				15
20	20,000	21,300	21,700	22,000			20
25	12,700	14,000	14,500	14,800	14,900		25
30	8,100	9,500	10,100	10,400	10,600	10,700	30
35		6,500	7,100	7,500	7,600	7,700	35
40		4,300	4,900	5,300	5,500	5,600	40
45		2,500	3,300	3,700	3,900	4,000	45
50				2,400	2,600	2,800	50

### Notes to lifting capacity

Lifting capacities do not exceed 85% of tipping load. Weight of hook blocks and slings is part of the load, and is to be deducted from the capacity ratings. Consult operation manual for further details.

Note: Data published herein is intended as a guide only and shall not be construed to warrant applicability for lifting purposes. Crane operation is subject to the computer charts and operation manual both supplied with the crane.

# RANGE DIAGRAM - MAIN BOOM

**RT 670**

**With Jib, 33 ft offset**

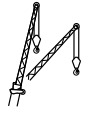

 with hook block:  
6 ft 9 in

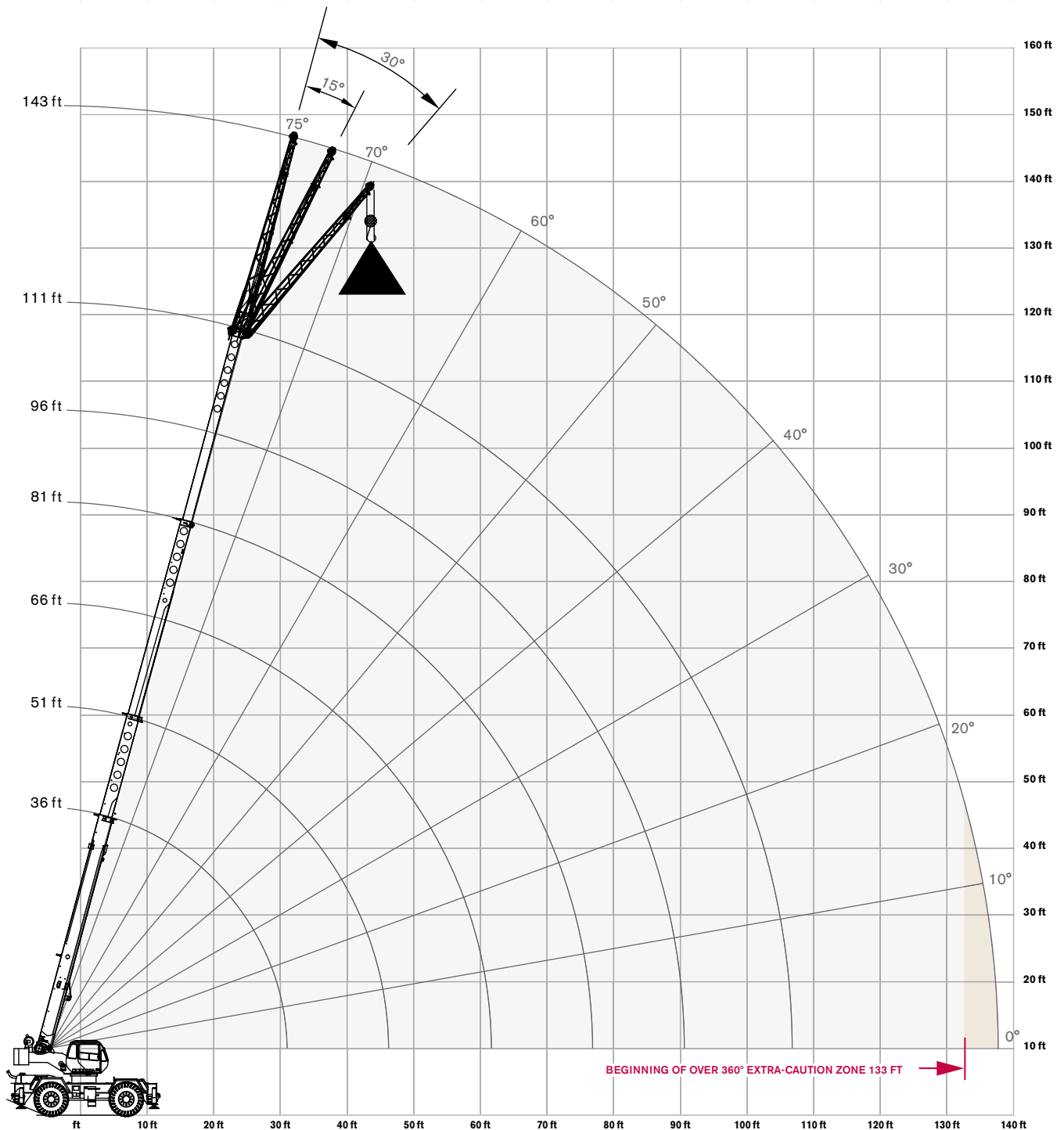



# LOAD CHART- MAIN BOOM

**RT 670**

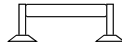

**With Jib, 33 ft offset**

 14,200 lbs counterweight

 Outriggers extended 24 ft (100%)

 360 degree rotation

Standard ASME B30.5

33 ft Offsettable Jib					
0° Offset		15° Offset		30° Offset	
 Radius (ft)	lbs	 Radius (ft)	lbs	 Radius (ft)	lbs
41	12,500	49	8,400	55	6,500
47	11,800	54	8,100	60	6,300
52	11,200	59	7,700	64	6,200
59	10,300	66	7,300	71	5,900
66	9,500	72	7,000	77	5,800
72	8,800	79	6,700	84	5,600
79	8,100	85	6,400	89	5,400
87	6,700	92	6,100	96	5,200
94	5,600	99	5,100	103	4,900
101	4,600	106	4,300	109	4,100
107	3,800	112	3,500	114	3,500
114	3,000	120	2,800	120	2,800
122	2,200	125	2,100	126	2,100
129	1,700	132	1,600		
135	1,200	137	1,200		

## Notes to lifting capacity

Lifting capacities do not exceed 85% of tipping load. Weight of hook blocks and slings is part of the load, and is to be deducted from the capacity ratings. Consult operation manual for further details.

Note: Data published herein is intended as a guide only and shall not be construed to warrant applicability for lifting purposes. Crane operation is subject to the computer charts and operation manual both supplied with the crane.

# RANGE DIAGRAM - MAIN BOOM

With Jib, 57 ft offset

RT 670

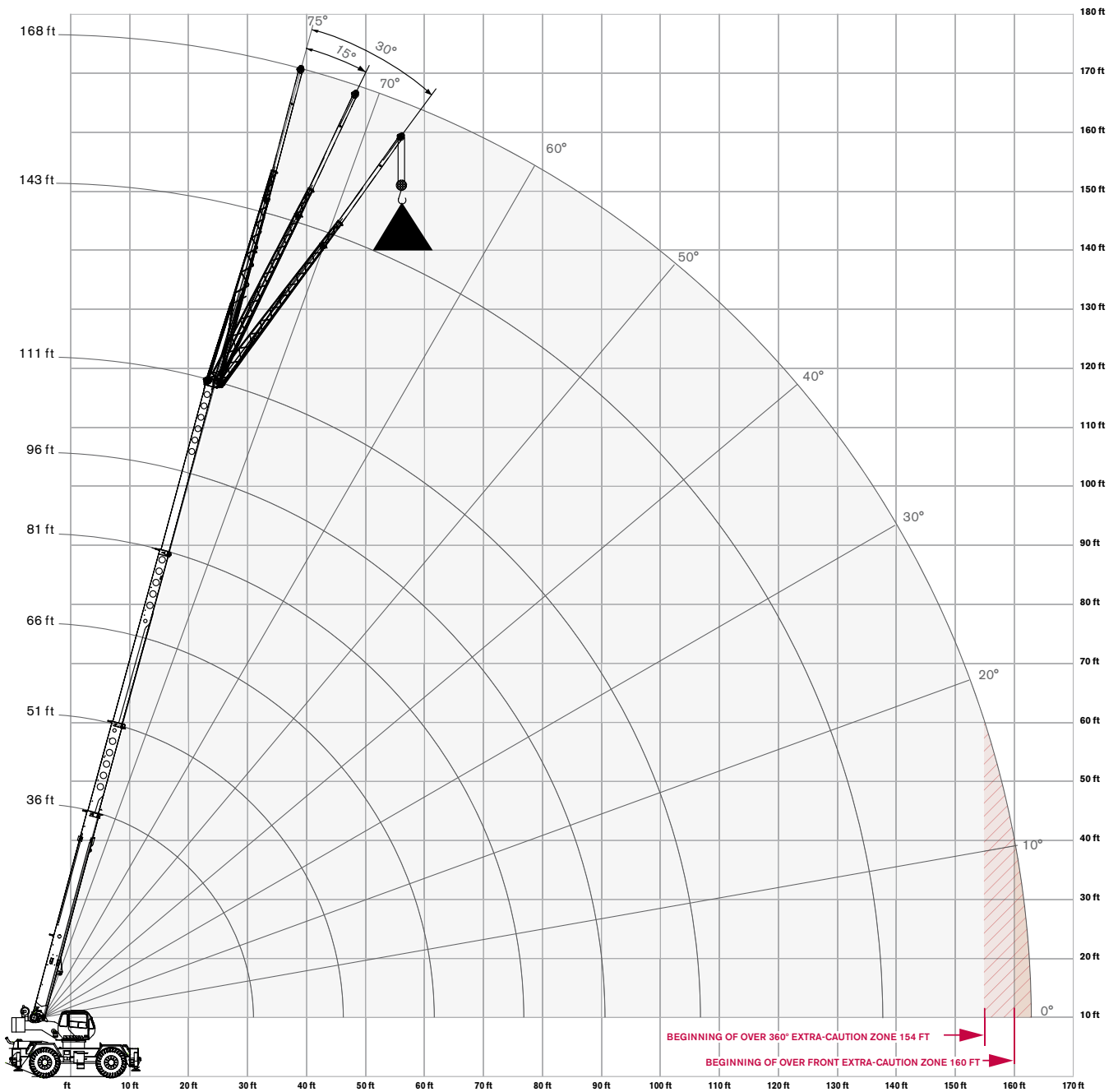
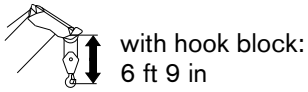
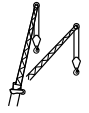



# LOAD CHART- MAIN BOOM

**RT 670**

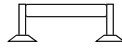

**With Jib, 57 ft offset**

 14,200 lbs counterweight

 Outriggers extended 24 ft (100%)

 360 degree rotation

Standard ASME B30.5

57 ft Offsettable Jib					
0° Offset		15° Offset		30° Offset	
 Radius (ft)	lbs	 Radius (ft)	lbs	 Radius (ft)	lbs
52	6,500	64	4,500	74	3,300
58	6,100	70	4,300	80	3,200
64	5,800	76	4,100	85	3,100
73	5,500	83	3,800	92	3,000
81	5,100	91	3,600	99	2,900
89	4,700	98	3,400	106	2,800
96	4,400	105	3,300	112	2,700
105	4,000	113	3,100	119	2,600
114	3,700	121	2,900	126	2,600
122	3,400	128	2,800	132	2,500
129	2,900	135	2,700	138	2,500
137	2,300	142	2,100	144	2,100
145	1,700	149	1,600	149	1,600
153	1,200	155	1,100		
159	900	160	800		

## Notes to lifting capacity

Lifting capacities do not exceed 85% of tipping load. Weight of hook blocks and slings is part of the load, and is to be deducted from the capacity ratings. Consult operation manual for further details.

Note: Data published herein is intended as a guide only and shall not be construed to warrant applicability for lifting purposes. Crane operation is subject to the computer charts and operation manual both supplied with the crane.

# RANGE DIAGRAM - MAIN BOOM

**RT 670**

**On Tires**

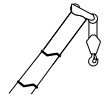

with hook block:  
6 ft 9 in

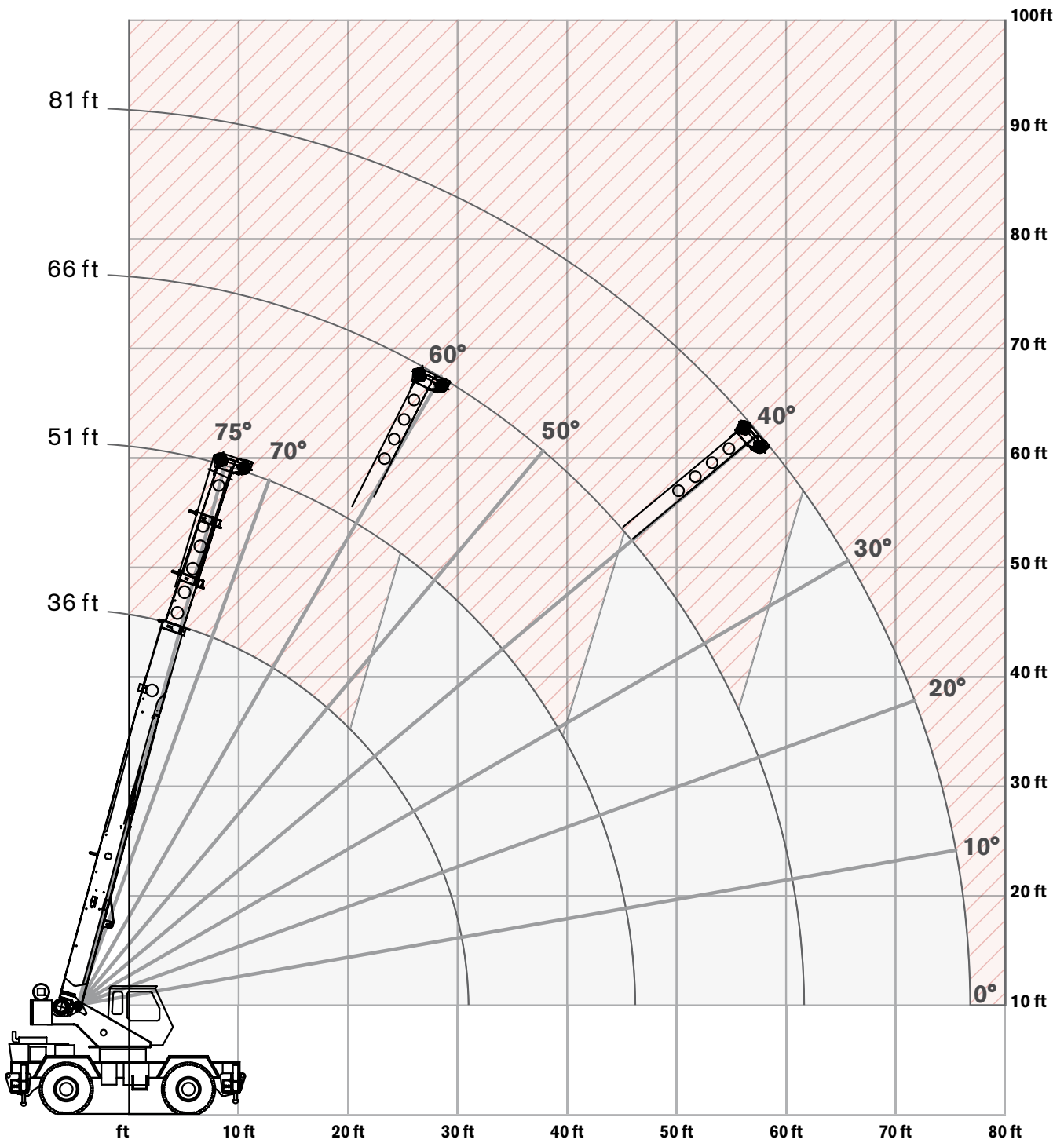



# LOAD CHART- MAIN BOOM

**RT 670**

## On Tires

 14,200 lbs counterweight

 360 degree rotation

 On tires  
29.5 X 25-28PR

Standard ASME  
B30.5

Boom		Travel Speed Boom straight over front		
Radius	Length	0 mph	Creep	2.5 mph
ft	ft	lb	lb	lb
10	36	87,500	68,700	51,800
12	36	77,200	60,400	45,300
15	36	61,300	50,700	37,600
20	36	37,200	37,200	28,700
25	51	22,500	22,500	22,500
30	51	15,600	15,600	15,600
35	51	12,600	12,600	12,600
40	51	10,100	10,100	10,100
45	66	8,000	8,000	8,000
50	66	6,400	6,400	6,400
55	66	5,100	5,100	5,100
60	81	4,100	4,100	4,100
65	81	3,300	3,300	3,300
75	81	2,600	2,600	2,600

## Notes to lifting capacity









Lifting capacities do not exceed 75% of tipping load. Weight of hook blocks and slings is part of the load, and is to be deducted from the capacity ratings. Consult operation manual for further details.

Note: Data published herein is intended as a guide only and shall not be construed to warrant applicability for lifting purposes. Crane operation is subject to the computer charts and operation manual both supplied with the crane.







# TECHNICAL DESCRIPTION

**RT 670**

## Boom

Standard configuration:	
	4 sections hydraulic actuated boom
	Full power mechanically synchronized
	Min. / Max. <span style="float: right;">36 ft / 111 ft</span>
	Boom elevation angle range (min. / max.) <span style="float: right;">-4° / 76°</span>
Optional configuration:	
	Single sheave
	One section, side stowable, with pull out insert Angular offsets <span style="float: right;">33 ft / 57 ft 0, 15 and 30 degrees</span>
	With one section jib (max.) <span style="float: right;">146 ft</span>
	With two section jib (max.) <span style="float: right;">170 ft</span>







## Hoist, Rope and Hook

Standard configuration:	
	Grooved drum Storage capacity <span style="float: right;">561 ft</span>
	Two speed ratios Without load in 5th layer (low range / high range) <span style="float: right;">269 ft/min / 431 ft/min</span> Without load in 1st layer (low range / high range) <span style="float: right;">187 ft/min / 300 ft/min</span>
	6 x 19 IWRC XIPS, right regular lay, preformed
	<span style="float: right;">3/4 in</span>
	<span style="float: right;">600 ft</span>
	Max. line pull; 1st layer low-range <span style="float: right;">18,450 lb</span> Max. line pull permissible <span style="float: right;">13,800 lb</span>





# TECHNICAL DESCRIPTION



**RT 670**

Optional configuration:		
	5 sheaves 5 sheaves	60 ton 75 ton
	Grooved drum Storage capacity	591 ft
	Without load in 5th layer (low range / high range) Without load in 1st layer (low range / high range)	269 ft/min / 431 ft/min 187 ft/min / 300 ft/min
	Rotation resistant compacted strand 34X7	
		3/4 in
		600 ft
	Minimum breaking strength Permissible line pull	69,000 lbs 13,800 lbs

## Superstructure

Standard configuration:		
	Non stop Maximum rotation speed without load	360° 1.9 rpm
	Hydraulic motor Planetary reducer 360° house lock	
	Manually actuated by foot pedal	

## Cab, Controls, Operator aids and Load limiter / Load indicator

Standard configuration:		
	Sliding door Hinged, tinted all glass skylight Six way adjustable seat	
	Armrest mounted dual axis electro-proportional joysticks Steering wheel column with gear selector on the left and directional light selector on the right Dashboard mounted switches for outrigger operation	
	Graphic interface for load indicator	

# TECHNICAL DESCRIPTION

**RT 670**

## Optional configuration:



Hydraulic powered air conditioner  
 Hydraulic powered heater  
 Work lights  
 Rotating beacon

## Carrier, Engine, Drive-line and Hydraulic system

### Standard configuration:



Hydraulic, independent extension:  
 Diameter of outrigger pads  
 Area of outrigger pads

24 in  
 452 in<sup>2</sup>



Cummins QSB6.7 6 cylinders  
 Rated power  
 Maximum gross torque  
 Intake: turbocharger with intercooler  
 Fuel type  
 Fuel tank capacity

215 hp @ 2,500 rpm  
 655 ft-lb @ 1,500 rpm  
 Diesel  
 50 gallons



6 x 6 powershift transmission with torque converter  
 Selectable 4WD (Four-Wheel Drive)  
 Rigid mounted front axle  
 Oscillating rear axle  
 Differential lock on front and rear axles  
 Rear axle oscillation lock - manual or automatic actuation  
 Air-over-hydraulic disc brakes  
 Front axle parking brake  
 Hydraulic oil cooler



Hydraulic power steering  
 Front wheel steering  
 Four wheel steering concentric  
 Four wheel steering crab



Hydraulic Pumps:

**Tandem pumps:**

Boom lift / Telescope  
 Power steering / Outriggers and swing

37.3 gal/min @ 3,500 psi  
 18.7 gal/min @ 3,500 psi

**Single pump:**

Main and auxiliary hoist pump

52.7gal/min @ 4,500 psi

Hydraulic oil reservoir capacity  
 Hydraulic oil suction filter  
 Hydraulic oil return filter

116 gallons  
 250 microns  
 5 microns

# TECHNICAL DESCRIPTION

**RT 670**

## Vehicle performance

		Standard configuration:	
	Max. in 1 <sup>st</sup> gear		127.6%
	Max. in 6 <sup>th</sup> gear		5.9%
<hr/>			
	Max. (6 <sup>th</sup> gear)		23.4 mph

## Tires

		Standard configuration:	
	Wide tread - Earth mover pattern		29.5 x 25-28PR

# RT 670

[www.terexcranes.com](http://www.terexcranes.com)

Effective Date: September 2010. Product specifications and prices are subject to change without notice or obligation. The photographs and/or drawings in this document are for illustrative purposes only. Refer to the appropriate Operator's Manual for instructions on the proper use of this equipment. Failure to follow the appropriate Operator's Manual when using our equipment or to otherwise act irresponsibly may result in serious injury or death. The only warranty applicable to our equipment is the standard written warranty applicable to the particular product and sale and Terex makes no other warranty, express or implied. Products and services listed may be trademarks, service marks or trade-names of Terex Corporation and/or its subsidiaries in the USA and other countries. All rights are reserved. Terex® is a registered trademark of Terex Corporation in the USA and many other countries. Copyright 2010 Terex Corporation..

Terex Cranes, Global Marketing, Dinglerstraße 24, 66482 Zweibrücken, Germany  
Tel. +49 (0) 6332 830, Email: [info.cranes@terex.com](mailto:info.cranes@terex.com), [www.terexcranes.com](http://www.terexcranes.com)

Brochure Reference: TC-DS-I-E-RT 670-09/10



**WORKS FOR YOU.™**